



T-K1 Instantaneous Water Heater

Installation Manual and Owner's Guide



Flash Water Heater™

Model T-K1

Suitable for potable water heating and space heating

FEATURING

- ENDLESS HOT WATER
- ON DEMAND
- COMPACT, SPACE SAVING
- ENERGY CONSERVING
- COMPUTER CONTROLS
- COMPUTERIZED SAFETY
- NO PILOT LIGHT

Takagi Industrial Co. USA Inc.
6 Goddard
Irvine, CA 92618
Toll Free (888) 882-5244
www.takagi-usa.com

FOR YOUR SAFETY - This product must be installed and serviced by a professional service technician or licensed person, qualified in water heater installation. Operation creates carbon monoxide gas and flue gases, which can cause serious injury or death. Improper installation and/or operation, or installation by an unqualified person, will void warranty.

WARNING: If the information in this manual is not followed exactly, a fire or explosion may result, causing property damage, personal injury or death.

- Do not store or use gasoline or other flammable vapors or liquids in the vicinity of this or any other appliance.
- WHAT TO DO IF YOU SMELL GAS
 - Do not use any appliance.
 - Do not touch any electrical switch, do not use any phone in your building.
 - Immediately contact your gas supplier from another location. Follow the gas supplier's instructions.
 - If you cannot reach your gas supplier, call the fire department.
- Installation and service must be performed by a qualified installer, service agency or the gas supplier.

Table of Contents

Specifications.....	2
For Your Safety.....	3
Operation.....	4
General.....	4
Turning It On.....	4
Turning It Off.....	4
Temperature.....	4
Flow.....	4
Freeze Protection.....	5
Installation.....	6
General.....	6
Accessories.....	6
Electrical Connections.....	6
Wiring Diagram.....	7
Gas Supply Piping.....	8
Water Plumbing.....	9
Pressure Relief Valve.....	9
Wall Hanging Installation.....	10
Standing Installation.....	10
Outdoor Installation.....	10
Indoor Installation.....	11
Combustible Air Supply....	11
Exhaust Venting.....	12
Manufactured Home (Mobile Home)	
Installation.....	12
Indoor.....	12
Outdoor.....	12
Initiating the Appliance.....	13
Initial Operation.....	13
Space Heating Application.....	14
Applications.....	17
Storage Tank.....	17
Recirculation.....	17
Maintenance.....	18
Troubleshooting.....	18
Optional Items.....	20
TK-RE01.....	20
TK-BK01.....	20
TK-TV01.....	20
TK-TV03.....	20
Exploded Diagram.....	21
Parts List.....	22
Flow Charts.....	23

Specifications

Natural Gas Input	Min. 37,000 Btu Max. 165,000 Btu
LPG Input	Min. 35,000 Btu Max. 165,000 Btu
Gas Connection	¾" NPT
Water Connections	¾" NPT
Water Pressure	Min. 15 psi Max. 150 psi
Natural Gas Pressure Inlet	Min. 5" WC Max. 10.5" WC
LP Gas Pressure Inlet	Min. 11" WC Max. 14" WC
Manifold Pressure	Natural 3.5" WC Propane 4.0" WC
Weight	60 lbs.
Dimensions	24.5"x16.5"x8.3"
Ignition	Electronic Ignition
Electrical Supply	AC 120 V

- Inlet gas pressure must not exceed the above maximum values.
- For gas pressures lower than 5" WC for natural gas, call the manufacturer.
- Before installing in areas over 4,500 feet above sea level, contact the manufacturer for high altitude adjustment instructions.
- Check the rating plate to insure this product matches your specifications.
- Takagi - USA is constantly improving our products, therefore specifications are subject to change without prior notice.

For Your Safety

PLEASE READ THIS MANUAL CAREFULLY AND FOLLOW IT EXACTLY FOR YOUR SAFETY.

1. Follow all local codes, or in the absence of local codes, follow the most recent edition of the National Fuel Gas Code, ANSI Z223.1/NFPA 54 in USA or the CGA standard, CAN/CGA B149.1 or .2 Installation Codes for Gas Burning Appliances in Canada.
2. Properly ground the unit in accordance with all local codes, or in the absence of local codes, with the National Electrical Codes, ANSI/NFPA 70 in the USA or CSA standard C22.1 Canada Electrical Code Part 1 in Canada.
3. Carefully plan where to install your Flash Water Heater. Insure that your heater will have enough combustible air, proper ventilation, and locate your heater where water leakage will not do damage to surrounding areas. If there is a possibility of water damage, install a suitable drain pan under the unit, which will not restrict combustible airflow.
4. Check the rating plate for the correct gas type, gas pressure, water pressure, and electrical rating. Do not install this unit if these requirements can't be met.

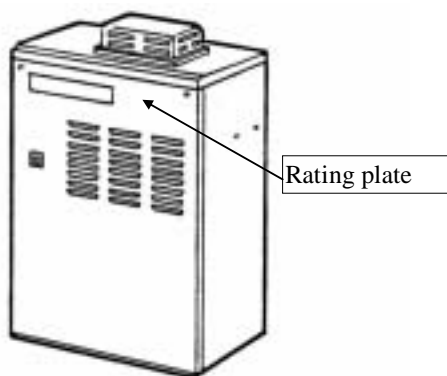

5. If a problem should occur, turn off all hot water taps and turn off the gas. Call a trained technician, the Gas Company, or the manufacturer.
6. **WARNING:** Do not disconnect the electrical supply if the temperatures will be near freezing. The Freeze Prevention

Device will only work if the unit has proper electrical power. The Freeze Prevention Device is rated for temperatures down to 5° F (-15° C) in a wind free environment. The wind chill factor will cause the Flash Water Heater to freeze and be damaged at temperatures above 5° F (-15° C). Refer to the sections on Winterizing and the Freeze Prevention Device for more information.

7. **WARNING:** Before bathing or showering always check the water temperature. Do not leave children or the infirm unsupervised in the shower or bath. The water temperature is set at 120° F (50° C) from the factory to maximize the amount of hot water you can use. Water temperature over 125° F can cause severe burns instantly or death from scalds.
8. **WARNING:** Do not use this appliance if any part has been underwater. Immediately call a certified and trained technician to inspect and service the unit if necessary.
9. **WARNING:** Do not store or use gasoline or other flammable vapors or liquids in the vicinity of this or any other appliance.
10. **WARNING:** Do not reverse the water and gas connections, this will damage your heater and can cause severe injury or death from scalds. Follow the diagram below when installing your Flash water heater.

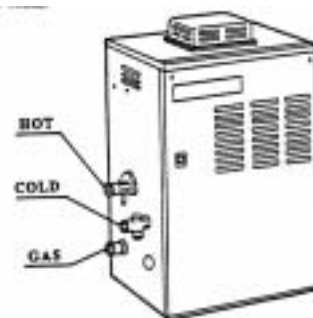

Operation

General

The Flash Water Heater is an instantaneous, tankless water heater designed to efficiently supply domestic or commercial hot water. The principle behind the Flash water heater is simple: Once a hot water tap is opened, the Flash's flow sensor detects that hot water is needed, and automatically commands the computer to electronically ignite the burners, and heat water. During operation, the computer monitors the water temperature and flow rate, and controls the gas flow and fan speed to maintain a constant output temperature. After the burners are ignited the "fire on" lamp will be lit.

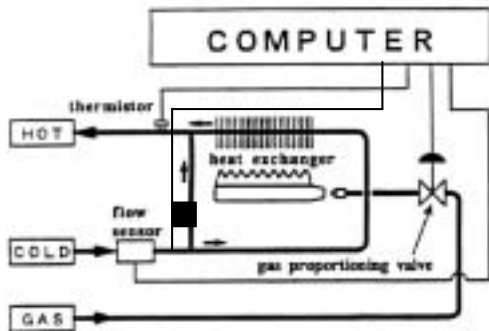

0.75 gallons per minute is required to turn the burners on, but after the burners are ignited, the flow rate can drop to 0.6 gallons per minute without the burners turning off.

As long as water, gas and electricity are connected, there will be an endless flow of hot water. To turn on your water heater, just open a tap. To turn the heater off, just close the tap.

Turning It On

To turn on the Flash water heater

1. Open a hot water tap, or turn on water demanding appliance.
2. Unit will detect flow, burners will ignite, "Fire On" lamp will light up.



3. If necessary, mix in cold water to get a comfortable temperature.

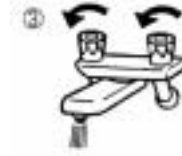

Turning It Off

To turn off the Flash water heater

1. Close the hot water tap, or turn appliance off.
2. Flow will diminish, unit will shut off.
3. "Fire On" lamp will go out.



Temperature

The output temperature of the T-K1 has been factory set for a maximum 120° F (50° C). This is electronically controlled by the computer and cannot be adjusted without a TK-RE01 temperature controller. Further adjustment may be made by mixing in cold water with the hot to obtain the ideal water temperature.

The actual outlet temperature is dependent on the inlet water temperature and the flow rate demanded. Consult the flow charts on the last page of this unit to determine the possible outlet temperature and flow rate combinations.

WARNING: Temperatures above 125° F (52° C) can cause severe burns or death from scalding. Children, the disabled and the elderly are at a high risk of being injured. Feel the water temperature before bathing or showering. Do not leave children, disabled persons, or the elderly unsupervised.

Flow

The flow rate through the T-K1 is limited to a maximum of 5.3 GPM. The flow rate, along with the supply temperature of the water will

determine the outlet temperature of the water. Consult the flow charts on the last page of this manual to determine the possible outlet temperature and flow rate combinations.

Based on the United States Department of Energy method of testing water heater output, the T-K1 is rated for 216 gallons per hour, or 3.6 GPM, at a 77° F rise above the inlet temperature. Refer to the following chart of typical household flow rates to determine what the T-K1 can do in a household application. Remember that for bathing, cold water will be mixed for a comfortable temperature, increasing the flow output rate.

Household Flow Rates	
Appliance / Use	Flow Rate (GPM)
Lavatory Faucet	1.0
Bath Tub	4.0
Shower	2.0
Kitchen Sink	1.5
Dishwasher	1.5
Washing Machine	2.0

Taken From UPC 1997

Freeze Prevention

This unit comes equipped with heaters that discourage the unit from freezing. For this freeze prevention system to operate there has to be electrical power to the unit.

The freeze prevention devices will not work if the electrical power source is disconnected.

The unit has been rated for temperatures down to 5° F (-15° C) in a wind free environment. The wind chill factor will cause the unit to freeze at temperatures above 5° F (-15° C), even if the unit is installed indoors. For indoor installation in areas where the temperature will be well below freezing for extended periods of time, extend the internal thermostat to the outdoors, and install a TK-TV03 backflow prevention kit so that cold air will not backflow into the flue and cause the unit to freeze. Do not install the water heater in an area with extremely cold weather. This will void your warranty and Takagi Industrial Co. USA Inc. will not be responsible for any damage that occurs.

WARNING: The pipe heaters are located on the Flash Water Heater only. Any hot or cold

water pipes located outside of the unit will not be protected. Properly protect and insulate these pipes from freezing.

If the heater will not be in use for a long period of time or if the temperatures will drop below 5° F (-15° C) with the wind chill factor, turn off heater and drain the unit of water. This applies to indoor and outdoor installations. This will keep the unit from freezing and being damaged.

Follow these instructions carefully:

1. Turn off the power supply to the Flash Water Heater.
2. Close manual gas control valve.
3. Close manual water shut off valve.
4. Open all hot water taps in the house. (Bathroom, kitchen, laundry room, etc.). When the water flow has ceased, close all hot water taps.
5. Have a bucket or pan ready to catch the water from the unit's drain plugs. Remove the drain plugs to drain the water out of the unit.
6. Let drain for 5 minutes.
7. Securely screw the drain plugs back into place.

Follow these steps when it is again safe to use the water heater:

1. Make sure all hot water taps are closed and the drain plugs are securely attached.
2. Purge the water line of debris.
3. Open manual water control valve located on the water supply line.
4. Open all the hot water taps to verify water flows to the taps. Close hot water taps.
5. Open manual gas control valve located on the gas supply line.
6. Turn on the power supply to the Flash Water Heater.

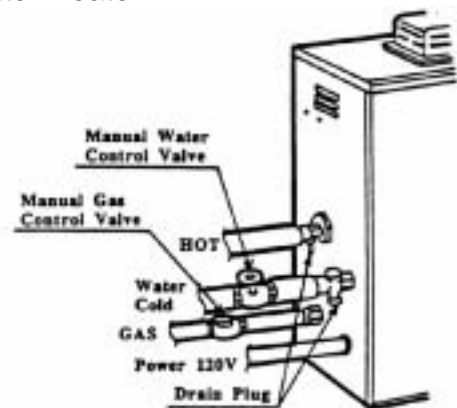

Installation

This section is for the installer. The installer is responsible for the correct installation of your Flash Water Heater.

For Your Safety: Only a certified and trained service technician or qualified plumber may service or install your product.

Please keep this owner's manual in a safe place for future reference. Copies of this manual are available from TAKAGI-USA





General

All gas water heaters require careful and correct installation to ensure safe and efficient operation. This manual must be followed exactly.

1. Read the For Your Safety section in the beginning of this manual.
2. This unit is not capable of being used as a pool or spa heater.
3. The regulator is preset at the factory. It is computer controlled and should not need adjustment.
4. Suitable for potable water heating only. Well water or hard water may cause scale problems that will not be covered by the manufacturer's warranty.
5. Maintain proper space for servicing. Install the unit so that it can be connected or removed easily.
6. Install so that the electrical power can be switched off if necessary.
7. Avoid installing in an area with high levels of dust, sand or debris. Particles may clog the air vent, reduce fan function, or cause improper combustion.
8. Do not install the unit where the exhaust vent is pointing into any opening in a building or where the noise may disturb your neighbors.

Accessories

Check that all the parts listed below were included with the unit.

PARTS NAME	SHAPE	NUMBER
Manual		1
Washers		4
Screws		4
Wall Mount Brackets		2
Anchor		4

Electrical Connections

The T-K1 requires a 60 Hz 120 VAC electrical power supply, and it should be properly grounded in accordance with the most recent edition of the National Electrical Code, ANSI/NFPA 70 and any local codes. In Canada, all electrical wiring to the heater should be installed in accordance with the Canadian Electrical Code, CSA C22.1 Part 1, and any local codes. Do not rely on the gas or water piping to ground the metal parts of the heater.

CAUTION: Label all wires prior to disconnection when servicing controls. Wiring error can cause improper and dangerous operation. Verify proper operation after servicing.

- A means for switching off the 120 VAC power supply must be provided.
- Wire the heater exactly as shown in the wiring diagram.
- A green screw is provided in the junction box for the grounding connection.

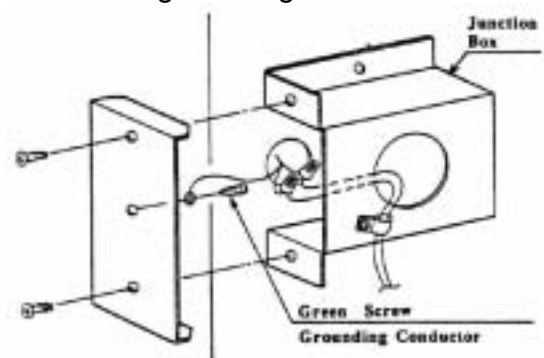

Refer to the following wiring diagram. Wiring diagrams are also printed on the inside panel of the appliance.

Wiring Diagrams

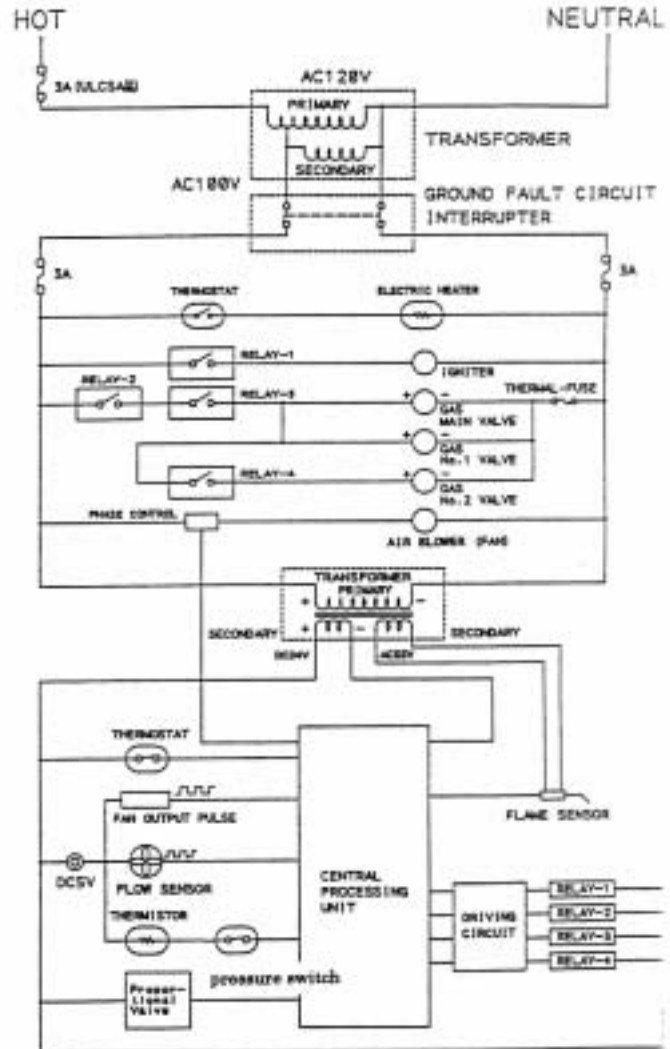
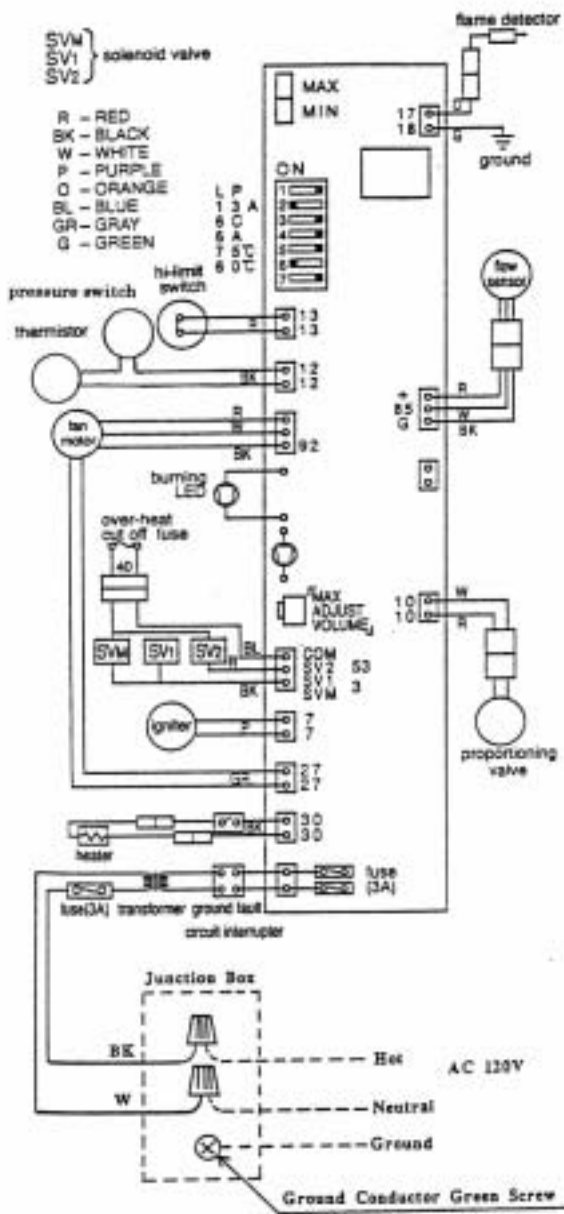

Electrical Rating

120 VAC, 60 Hz, 0.8 A.

Note : If any of the original wiring supplied with this appliance must be replaced, it must be replaced with appliance wiring material (180c) or its equivalent. Wires are available through the manufacturer.

Gas Supply Piping

Check the rating plate to make sure that the unit was built for the type of gas available in the area.

The gas supply piping should be sized according to the Applicable Plumbing Code for a maximum draw of 165,000 BTUH. First determine the effective length of the gas supply line by measuring the actual length of piping, and then adding 5 ft. for every elbow or "T" to the actual length. Use the charts below to determine the pipe diameter necessary to accommodate the BTU demand of the unit. If there are more gas drawing appliances on the line, size according to the maximum amount of BTU demand.

The gas supply pressures must be within the ranges of the following chart:

Natural Gas Supply Pressure	Min. 5" WC Max. 10.5" WC
Propane Gas Supply Pressure	Min. 11" WC Max. 14" WC

Insufficient gas supply pressure can cause the Flash Water Heater to lose efficiency or not work at all.

WARNING: Fire or explosion may result if the maximum supply pressures are exceeded.

The manifold gas pressure should be at maximum 3.5" WC for natural gas, and 4.0" WC for propane.

Always use approved connectors to connect the unit to the gas line. Always purge the gas line of any debris before connecting to the water heater.

WARNING: Conversion of this unit from natural gas to propane or propane to natural gas cannot be done in the field. Contact your local retailer or distributor to get the correct unit for your gas type.

Always install a manual shutoff valve on the gas supply line in case of an emergency, or if service or maintenance is necessary.

This appliance and its individual shut-off valve must be isolated from the gas supply piping system by unplugging the unit and turning off the main gas valve during any pressure testing of the gas supply piping system at test pressures equal to or less than ½ PSI.

When all of the connections have been made, check the gas line for leaks. Apply soapy water to all gas fittings and connections, if bubbles form, there may be a leak.

Natural Gas Supply Piping

Based on 0.60 specific gravity for natural gas at .5" WC pressure drop
DOE standard is 1100 BTU per cubic ft. of natural gas

Pipe Size	Cubic Feet of Natural Gas													
	Length	10'	20'	30'	40'	50'	60'	70'	80'	90'	100'	125'	150'	200'
½"	174	119	96	82	73	66	61	56	53	50	44	40	34	
¾"	363	249	200	171	152	138	127	118	111	104	93	84	72	
1"	684	470	377	323	286	259	239	222	208	197	174	158	135	
1 ¼"	1404	965	775	663	588	532	490	456	428	404	358	324	278	
1 ½"	2103	1445	1161	993	880	798	734	683	641	605	536	486	416	
2"	4050	2784	2235	1913	1696	1536	1413	1315	1234	1165	1033	936	801	

Propane Supply Piping

Based on 11" WC supply pressure

Pipe Size	kBTU of Propane													
	Length	10'	20'	30'	40'	50'	60'	70'	80'	90'	100'	125'	150'	200'
½"	275	189	152	129	114	103	96	89	83	78	69	63	55	
¾"	567	393	315	267	237	217	196	185	173	162	146	132	112	
1"	1071	732	590	504	448	409	378	346	322	307	275	252	213	
1 ¼"	2205	1496	1212	1039	913	834	771	724	677	630	567	511	440	
1 ½"	3307	2299	1858	1559	1417	1275	1181	1086	1023	976	866	787	675	
2"	6221	4331	3465	2992	2646	2394	2205	2047	1921	1811	1606	1496	1260	

Water Plumbing

Follow local guidelines for the length of the plumbing line in order to ensure that there is enough water pressure for all the fixtures on the line. First, calculate the effective length of the plumbing line by measuring the total length of pipe, and then adding to this 5' for each elbow or tee in the line. Use the following chart to determine the total number of fixture units on the line, and then compare with the chart at the bottom of this page to find the pipe diameter and water pressure necessary.

Fixture Unit Per Fixture (from UPC)	
Plumbing Fixture Description	Fixture Unit
Combination Bath / Shower	4
Whirlpool Bath	4
Shower	2
Lavatory	1
Clothes Washer	4
Dishwasher	1.5
Kitchen Sink	1.5

Install with control valves on the inlet and outlet, and use removable unions or connectors to facilitate maintenance or service if necessary.

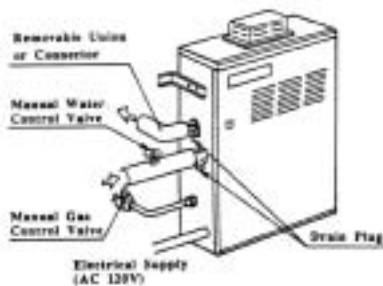

If the water heater is installed in a closed water system, means shall be provided to control thermal expansion. Contact the water supplier or a local plumbing inspector on how to control this situation.

Purge the water line of air, and clean the filter before initial operation.

WARNING: Do not reverse the hot outlet and cold supply line connections to the Flash Water Heater. Make sure the hot and cold lines are connected as in the FOR YOUR SAFETY section at the front of this manual.

Pressure Relief Valve

An approved pressure relief valve must be installed in any installation with this unit. The pressure relief valve must be installed on the hot line out of the unit, with no check valves or control valves between the unit and the relief valve.

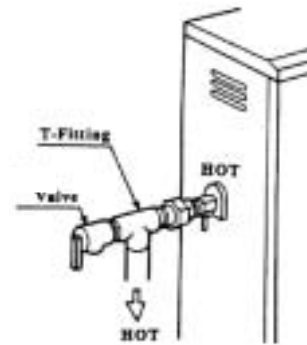

The Pressure relief valve must be rated for 150 PSI, and have a discharge capacity of 165,000 BTU. Connect the discharge opening of the relief valve to a suitable drain to prevent water damage should discharge occur.

If the pressure relief valve discharges periodically, this may be due to thermal expansion in a closed water supply system. Contact the water supplier or local plumbing inspector on how to correct this situation.

Do not plug the pressure relief valve. The line should have no reduced fittings or other restrictions and should allow for complete drainage of valve and line. The pressure relief valve should be manually operated once a year to check for correct operation.

Should overheating occur or the gas supply fail to shut off, turn off the manual gas control valve to the appliance.

Pipe Size	Length to the End of Hot Water Line and Recommended Fixture Units											
	Pressure Range 30 to 45 PSI				Pressure Range 46 to 60 PSI				Pressure Range 60+ PSI			
	100'	200'	300'	400'	100'	200'	300'	400'	100'	200'	300'	400'
3/4"	3-12	1-6	1-5	0-4	5-17	3-11	2-8	1-6	6-20	4-13	3-10	2-8
1"	12-25	6-17	5-13	4-12	17-36	11-25	8-20	6-18	20-39	13-32	10-26	8-22
1-1/4"	25-48	17-32	13-25	12-21	36-78	25-52	20-39	18-33	39-78	32-74	26-54	22-43

Wall Hanging Installation

For a wall mount installation, use TK-BK01 brackets to securely attach the T-K1 to the wall.

Locate the heater as desired, but follow all applicable local codes, as well as the indoor or outdoor clearances that apply to the installation.

Standing Installation

If the unit is to be installed standing on a surface, adjust the legs so that the unit stands securely and is level (legs can be adjusted up to 1").

Do not install the unit standing directly on a combustible surface. Use a 3" non-combustible base.

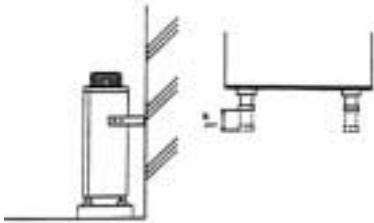

Use the included L brackets to connect the unit to a wall to ensure that it does not fall over. These brackets will maintain the required 1" clearance between the back of the unit and a combustible surface.

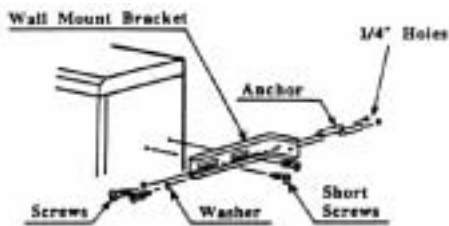

Outdoor Installation

Follow all local codes, or in the absence of local codes, follow the codes for Installation of Gas Burning Appliances; National Fuel Gas Code ANSI Z221.23 in USA or CAN/CGA B149.1 or .2 in Canada.

For outdoor installation, do not remove the vent cap from the top of the appliance.

Locate the water heater in an open, unroofed area, and maintain the following minimum

clearances from combustible and noncombustible materials.

Outdoor Clearances

Piping side	12"
Front (Maintenance space)	24"
Floor	Non combustible base Min. 3" off the ground
Back of heater	1"
Non piping side	2"
Top of heater	36"

If this unit is installed under an overhang, there must be a 36" clearance from the top of the unit to the overhang, and the surrounding area must be open in front and on the sides of the unit.

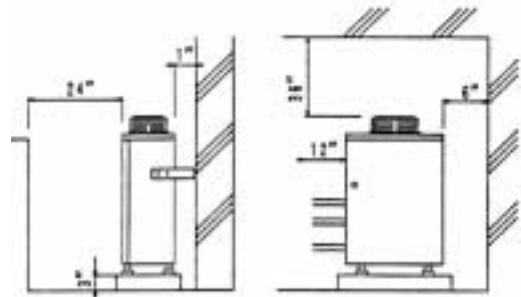

WARNING: Do not have the flue terminal pointing toward any opening into a building. Do not locate your heater in a pit or any location where gas and water can accumulate.

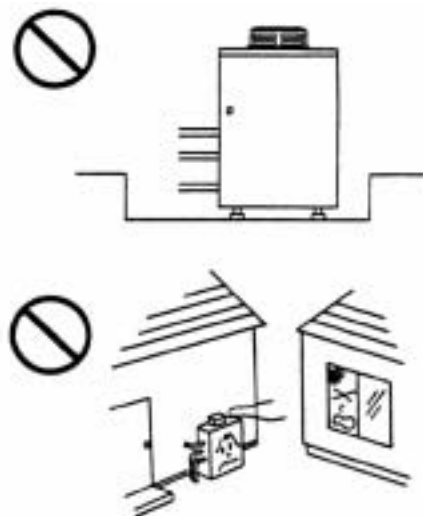

WARNING: Do not install the heater where water, debris, or flammable vapors may get into the flue terminal. This may cause damage to the heater.

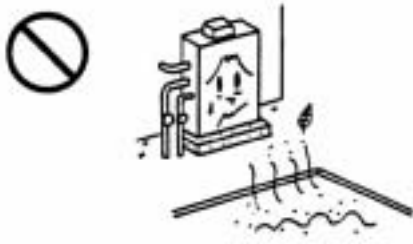

WARNING: United States regulations forbid installing the unit within 4' of any opening into any building. Similar Canadian regulations forbid the unit from being installed within 10' of any opening into any building.



WARNING: Improper installation can cause nausea or asphyxiation from carbon monoxide and flue gases which could result in severe injury or death.

For installation in altitudes above 4,500 feet, contact the manufacturer for instructions.

Indoor Installation

Follow all local codes, or in the absence of local codes, follow the codes for Installation of Gas Burning Appliances; National Fuel Gas Code ANSI Z221.23 in USA or CAN/CGA B149.1 or .2 in Canada.

WARNING: In an indoor installation, the T-K1 must be connected to a Category III special gas vent in order to direct the dangerous exhaust byproducts to the outdoors.

Remove the vent cap from the top of the unit, and connect the Category III exhaust flue to the 4" round connector underneath.

Cut the black jumper wire loop on the pressure switch to activate the unit's indoor installation safety features.

WARNING: Do not install the unit directly on a combustible surface such as carpeting, wood

floors, etc. If it is necessary to install the unit standing on a surface, install a 3" noncombustible base between the unit and the surface.

Combustible Air Supply

The T-K1 must be installed in a location where the proper amount of combustible air will be available to it at all times. If the unit is installed in a confined space, there must be permanent openings supplying air to the unit. If the openings will bring air directly from the outdoors, two openings are required, and they should be sized to give a minimum free area of one square inch for every 4000 BTUH of the maximum input rating of the unit.

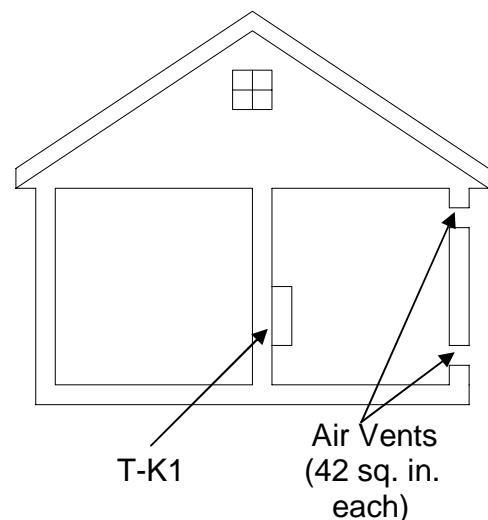

If the openings will bring air from another indoor area, they should be sized to give a minimum free area of one square inch for every 1000 BTUH of the maximum input rating of the unit.

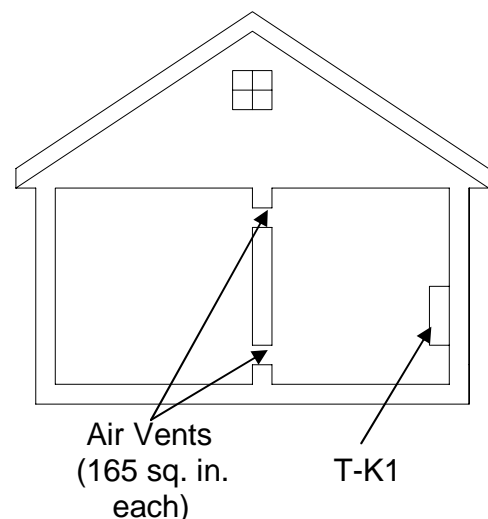

One of these openings should be within 12" of the ceiling, and the other should be within 12" of the floor.

Exhaust Venting

This water heater must be vented in accordance with the section on venting of equipment in the latest edition of the National Fuel Gas Code.

This is a Category III appliance, and must be vented accordingly. The following are UL listed manufacturers: ProTech Systems FasNSeal, Z-Flex Inc. Z Vent II and Heat-Fab Inc. Saf-T Vent. Follow the vent pipe manufacturer's instruction when installing the vent pipe. Do not common vent this appliance with any other vented appliance.

The venting system must not exceed a length of 21 ft. minus 5 ft. for every elbow. Do not use more than 3 elbows.

No. of Elbows	Max. Vertical or Horizontal Length
0	21 ft.
1	16 ft.
2	11 ft.
3	6 ft.

If the horizontal vent run exceeds 5 ft., the following criteria must be observed:

- There must be a 2 ft. vertical run off the top of the heater before the horizontal run begins.
- The horizontal run must be supported at 3' intervals.
- The vent run should be pitched up towards the termination at 1/4" per foot.

The unit can be vented either up and out the roof, or directly through a wall. If the unit will be vented through a wall, use Takagi USA Inc. optional part, the TK-TV01 vent terminator, or an equal Category III vent part. Locate the vent terminator according to ANSI Z223.1/NFPA 54 and applicable local codes. Maintain the following clearances to any combustible surface in an indoor installation:

Indoor Clearances

Piping side	6"
Front (Maintenance space)	Suggested 24" Min. 4"
Floor	Noncombustible base
Back of heater	1"
Non piping side	2"

Top of heater	11"
---------------	-----

Manufactured Home (Mobile Home) Installation

This appliance must be installed in accordance with the Manufactured Home Construction and Safety Standard, (Title 24, CFR; Part 3280) and ANSI A119.5/NFPA 501D. In addition, install in accordance with the following instructions, the instructions supplied with any venting, local codes, utility company requirements for the installation of water heaters in manufactured homes (mobile homes), and the latest edition of the National Fuel Gas Code, ANSI Z221.3/NFPA 50.

Locate the heater in an enclosure separating the unit from the internal atmosphere of the manufactured home or trailer. All combustion air must be obtained from the outside atmosphere, and the flue gases must be discharged directly outdoors through a gas vent. There must be no opening from the interior of the home or trailer into the water heater enclosure.

Indoor Installation

Follow indoor installation instructions as set out in an earlier section of this manual, except that combustion air must not be taken from the inside of the home or trailer.

Outdoor Installation

Follow outdoor installation instructions as set out in an earlier section of this manual.

If the unit is to be installed in a recessed area, connect a gas vent to the unit, which will direct exhaust gases out of the recessed area.

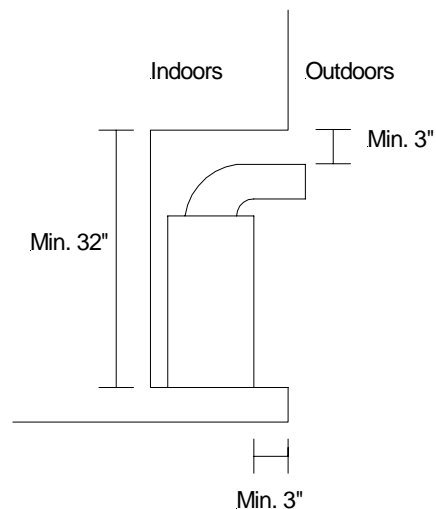

Initiating the Appliance

For your safety, read before operating.

WARNING: If you do not follow these instructions exactly, a fire or explosion may result causing property damage, personal injury or loss of life.

- a) This appliance does not have a pilot. It is equipped with an electronic ignition device, which automatically lights the burner. Do not try to light the burner by hand.
- b) Before operating, check for gas accumulation in the area around the appliance. Pay special attention near the floor, because gas is often heavier than air, and it may accumulate near the floor.
- c) Do not attempt to open the manual gas shutoff valve with anything but by hand. Never use tools. If the valve will not open by hand, do not try to repair it. Instead, call a qualified service technician. Force or attempted repair may result in a gas leak, fire or explosion.
- d) Do not use this appliance if any part has been under water. Immediately call a qualified service technician to inspect the appliance and to replace any part that may have been damaged by being under water.

WARNING: IF YOU SMELL GAS:

- Do not use any appliance.
- Do not touch any electric switch, do not use any phone in your building.
- Immediately call your gas supplier from a neighbor's phone. Follow the gas supplier's instructions.
- If you cannot reach your gas supplier, call the fire department.

Initial Operation

1. STOP! Do not operate without reading the safety information first!
2. Switch off the electrical power supply to the heater.
3. Do not attempt to light the burner manually.
4. Turn the manual gas control valve located on the outside of the unit counterclockwise to the OFF position.
5. Wait five (5) minutes to clear out any gas. If you then smell gas, STOP! Follow "b" in the "Initiating the Appliance" section above. If you do not detect gas, proceed to the next step.
6. Turn the manual gas control valve located on the outside of the unit clockwise to the ON position.
7. Turn on the electrical power to the appliance.
8. Turn on any tap, and the T-K1 will initiate itself.
9. If the appliance will not operate, follow the instructions in the "Turning Off the Gas Supply to the Appliance" section following, and call a service technician or gas supplier.

TURNING OFF THE GAS SUPPLY TO THE APPLIANCE

Close the manual valve on the gas inlet line. Turn off the power supply.



Manifold pressure taps.

Space Heating Application

The FLASH T-K1 can be used for space heating as well as potable heating of hot water applications.

WARNING

- Toxic chemicals such as used for boiler treatments chemical, alcohol, glycerol and glycol group will not be introduced into the system when used for potable water and space heating.
- The FLASH T-K1 can be used to supply potable water and space heating and shall not be connected to any heating system or component(s) previously used with non-potable water where any chemicals were added to the water heating appliances.
- When the system requires water for space heating at temperatures higher than required for other used, a means such as a mixing valve shall be installed to temper the water for those uses in order to reduce scald hazard potential.
- Water temperature over 125 °F can cause severe burns instantly or death from scalds.
- Chemicals such as diluted Glycol can be used for radiant floor, Hydro-warm air or Baseboard heating only.

Basic system drawings and Schematics.

Heating application only:

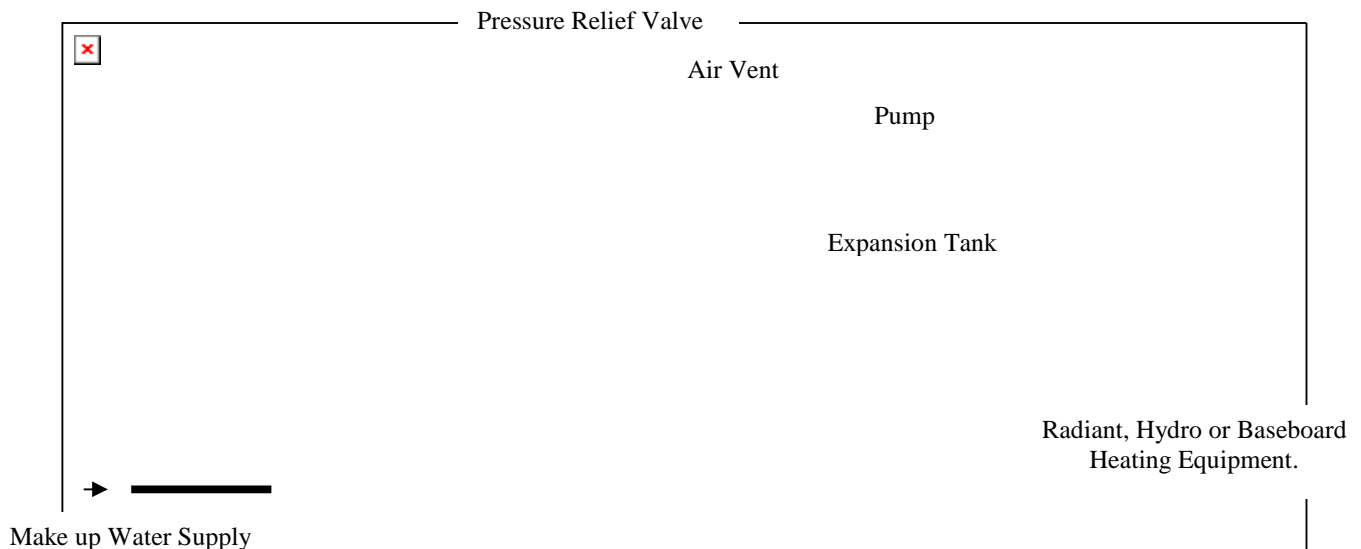

Warning: This illustration is for concept only. There are a wide variety of variations to the application of controls and equipment presented applications. Designers must add all necessary safety and auxiliary equipment to conform to code requirements and design practice.

For more details, contact Technical Department at (888) 882-5244

Dual-purpose hot water heating (Domestic and Heating):

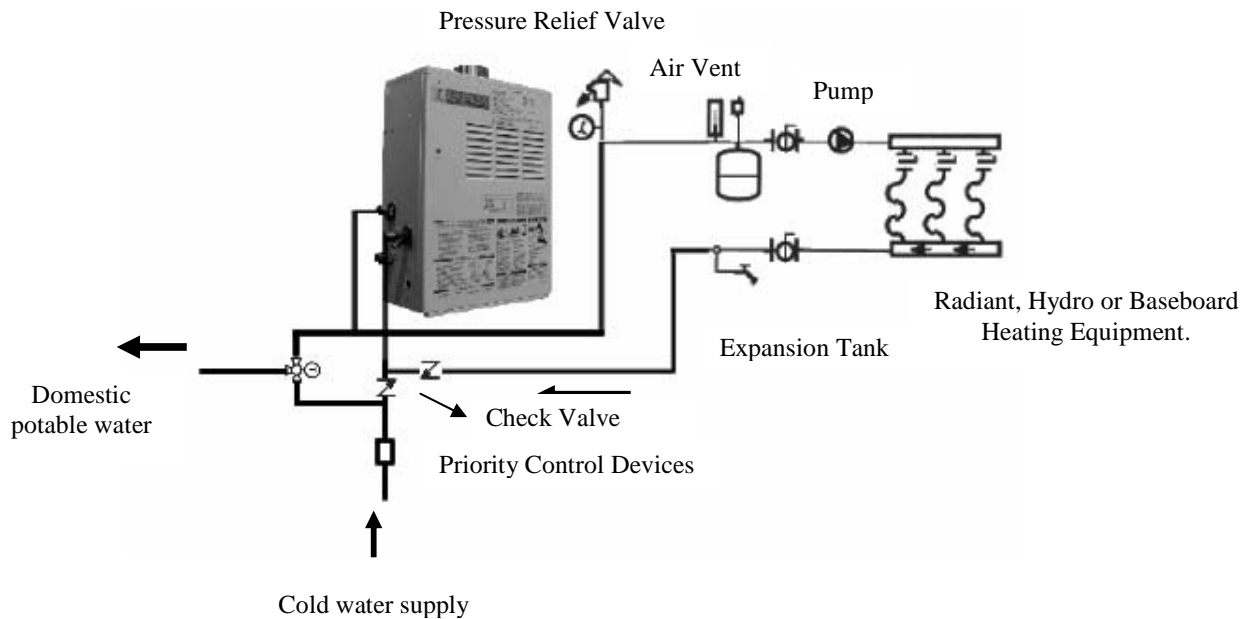

Priority Control Devices: It has a capability to make priority system that can be used as a controller flow sensor, Aquastat, or electronic controller to controlling radiant, Hydro or baseboard heating equipments.

Warning: Follow all local codes, or in the absence of local codes, follow the most recent edition of the National Standard Code, ANSI Z21. 10.3.

Warning: This illustration is for concept only. There are a wide variety of variations to the application of controls and equipment presented applications. Designers must add all necessary safety and auxiliary equipment to conform to code requirements and design practice.

For more details, contact Technical Department at (888) 882-524

FOR YOUR SAFETY READ BEFORE OPERATING

WARNING: If you do not follow these instructions exactly, a fire or explosion may result causing property damage, personal injury or loss of life.

A This appliance does not have a pilot. It is equipped with an ignition device which automatically ignites the burner. Do not try to light the burner by hand.

B BEFORE OPERATING, smell all around the appliance area for gas. Be sure to smell near the floor because some gas is heavier than air and will settle on the floor.

WHAT TO DO IF YOU SMELL GAS

- Do not try to light any burners.
- Do not touch any electrical switches, do not use your telephone or create any sparks.
- Immediately call your gas supplier from a neighbor's phone. Follow the gas supplier's instructions.

* If you cannot reach your gas supplier, call the department.

C Use only your hand to push in or turn the gas control knob. Never use tools. If the knob will not push in or turn by hand, do not try to repair it. Call a qualified service technician to repair or replace the knob or the gas control knob. Only a qualified technician should attempt to service or adjust the burner and any other gas control parts on this appliance.

D Do not use the appliance if any part has become loose or detached. Call a qualified service technician to inspect the appliance and to repair any parts that are loose or missing.

OPERATING INSTRUCTIONS

1. STOP! Read the safety information above on this label.
2. Turn off all electric power to the appliance.
3. Do not attempt to adjust the burner by hand.
4. Turn the gas control manual valve located on the outside of the unit on (clockwise) to the off position.
5. Wait five (5) minutes to clear out any gas. If you then smell gas, STOP - follow "D" in the safety information above on this label.
6. Turn the gas control manual valve located on the outside of the unit on (clockwise) to the on position.
7. Turn on all electric power to the appliance.
8. If the appliance will not operate, follow the "Troubleshooting" and/or your service technician or gas supplier.

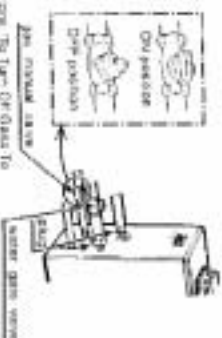

TO TURN OFF GAS TO APPLIANCE

1. Turn off all electric power to the appliance.
2. Turn the gas control manual valve located on the outside of the unit on (clockwise) to the off position.

▲ DANGER



A vapor from flammable liquids will explode and catch the burning match or spark from any lit match.

Do not use or store flammable products such as gasoline, kerosene, oil, or other liquids near the water heater. These are the kind of flammable products.

1. Use fresh hot water.
2. In approved containers.
3. Spills cleaned and dried.
4. Out of children's reach.

Do not touch water heater. Do not touch flammable products. All flammable products should be stored or used in a well-ventilated area.

▲ WARNING

The actual temperature of the flame is set at 1407°F (769°C). The burner is designed. It may require water temperature control for safety. Do not use this burner.

WARNING: Use the handle of your oven rack. The set of oven water temperature can cause severe burns, scalding, or other injury. Do not use the handle for anything else. Do not leave children or the frail unsupervised. See your local water supply company (sanitary bathroom water) for temperature setting values for the burner.

▲ DANGER



Water temperature over 125°F can cause severe burns instantly or scalding soon thereafter.

Children, disabled and elderly are at highest risk of being scalded. Feel water before using or adjusting.

Temperature setting values are available, see manual.

▲ WARNING

WARNING: Call your physician or a general laboratory system in the case of cancer, skin disease, death, cancer, or other reproductive harm. The product may contain such substances. Do not use the product. Call your physician or a general laboratory system in the case of cancer, skin disease, death, cancer, or other reproductive harm.

F1501B

Applications

The T-K1 can be installed in a variety of plumbing applications, which will provide more comfortable domestic hot water. Contact Takagi for information on using this unit as a heat source.

T-K1 with Storage Tank

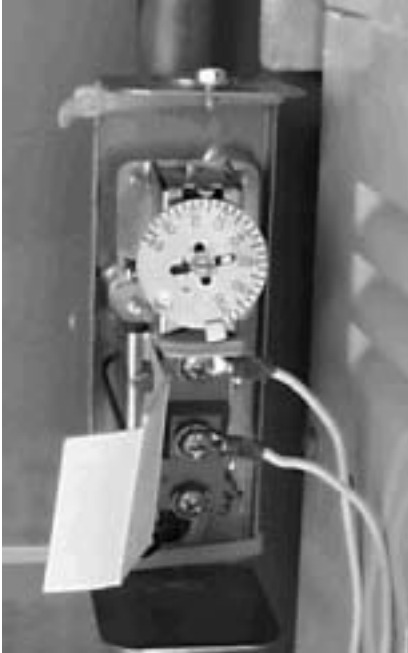

Aquastat

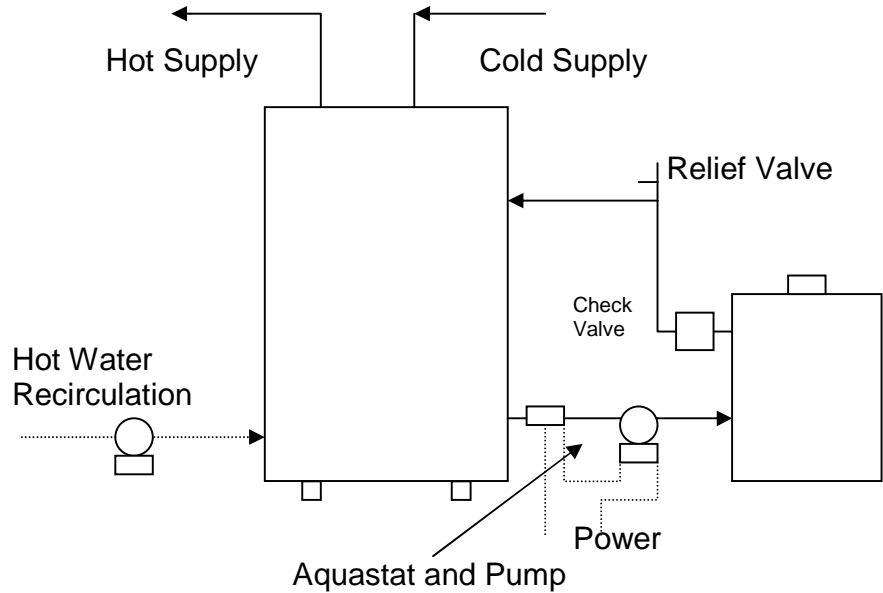

The maximum flow rate through the T-K1 is 5.3 GPM. If it is necessary to achieve higher flow rates for longer periods of time, then it can be installed in conjunction with a storage tank. A pump will be necessary to keep the water hot, and it should be controlled by an Aquastat, set at 120° F max. with a 10° F differential. We suggest a pump of 1/12 hp or greater depending on the system.

Recirculation

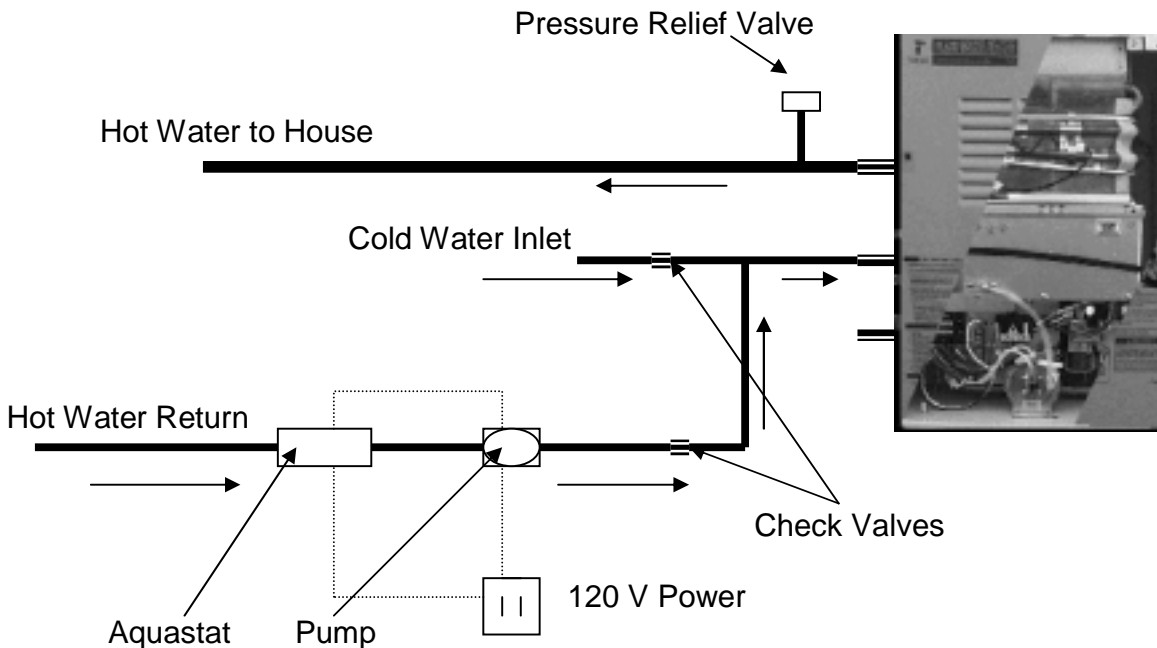

This system will need a pump controlled by an aquastat. Set aquastat at 95° F with a 10-15° F differential. Use a pump of 1/12 hp or greater, depending on the system.

Maintenance

WARNING: Turn off the electrical power supply, the manual gas control valve, and the manual water control valve before servicing.

The unit should be checked once a year or as necessary by a certified and trained technician. If repairs are needed, the repairs should be done by a certified and trained technician.

The following systems and parts should be checked at least once a year:

1. Venting systems
2. Burners
3. Manual operation of the pressure relief valve to ensure correct operation.
4. Periodic cleaning of the water filter, refer to figure below.
5. Heat exchanger. Remove the thermistor and check for a mineral coating . A mineral coating on the thermistor requires flushing the heat exchanger with a descaling solution. Scale build up will void your warranty and shorten the life of your water heater.

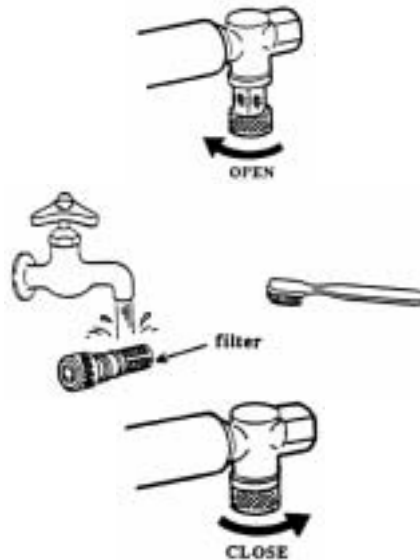

Troubleshooting

Water Isn't Hot Enough

The T-K1 can burn gas at a maximum input rate of 165,000 BTUH. This puts a limit on the possible output temperature and flow capabilities (See flow chart on the last page of this manual). If the water isn't hot enough, turn down the flow rate through the unit. If it still isn't hot enough, compare the flow and temperature that is being attained to the T-K1 flow vs. temperature chart. If the unit is not performing according to the chart, first check that the gas supply line is sized properly, and that the gas pressure is within the required range. If the gas line is okay, check the plumbing for mixing valves, thermostatic valves, scald protection, single handled valves or crossed connections. If the unit is performing in accordance with the flow chart, then it may be undersized for the application.

It Takes Too Long to Get Hot Water

The T-K1 takes three seconds to ignite, and three more to get up to temperature. The rest of the time needed for hot water to get to a fixture is due to the length of piping between the water heater and the fixture. If the unit seems to be taking longer than six seconds to initiate, check the filter and flow sensor for any debris or damage.

The T-K1 Will Not Initiate

First check the flow rate through the unit. If the flow is not .75 GPM or greater, the unit will not initiate. Check the filter and the flow sensor for any debris or damage.

Press the lower green button on the GFCI inside the unit. If the red light above it does not come on, then there is a problem with the electrical supply to the unit. If that light does come on, hit the green reset button above the light, and look for a small red LED in the lower hole in the middle of the T-K1 circuit plate. If this light is not lit, there is a problem with the electrical connection between the GFCI and the circuit plate. Contact Takagi Industrial Company for Instructions.

Error Codes

All Takagi units are self diagnostic for errors. If there is a problem with the installation or the unit, it will give a signal, through a pair of flashing lights on the circuit plate, to communicate the source of the problem. If the unit has a TK-RE01 remote control installed, this will give also give a numerical error code. Consult the following chart for the meaning of an error code:

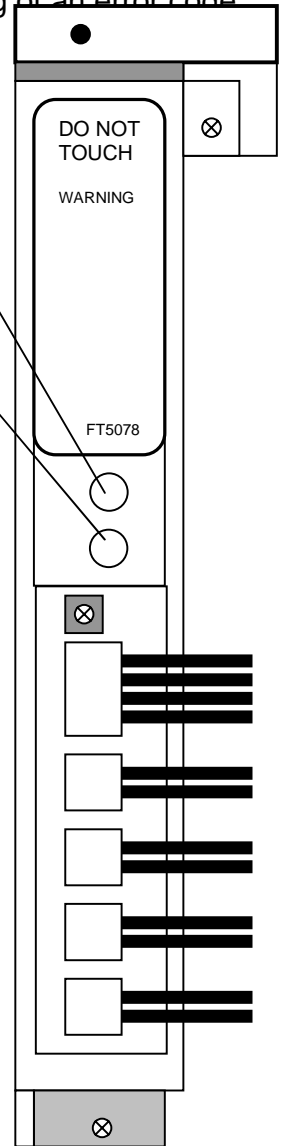
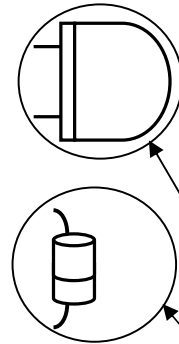
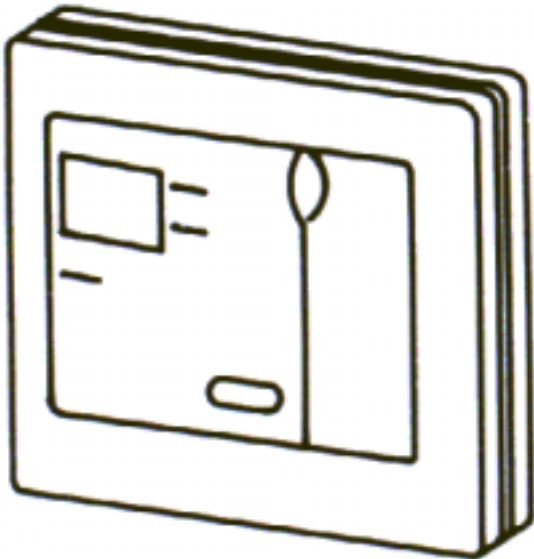

Upper	Lower	No.	Problem	Possible parts to check
Blinking	Off	11	Igniter	Computer, Igniter, Flame rod, gas valve, gas resource
		12	Burner flame	Computer, Flame rod, gas valve, gas resource
		72	Pre post check	Computer, Flame rod, gas valve, gas resource
Off	Blinking	14	Computer, gas valve, hi-limit switch,	Computer, hi-limit switch, gas valve
		71	Computer, gas valve	Computer, gas valve
Blinking Together		45	Fan motor	Computer, fan motor
Blinking Alternately		31	Thermister, pressure switch	Computer, thermister, pressure switch
Off	Off	Off	Electric supply	Computer, GFI, fuse, wire, connection outer electric resource

Optional Items

TK-RE01 Temperature Remote Controller



The TK-RE01 Temperature Remote Controller has two functions, it allows the maximum output temperature from the T-K2 to be

adjusted within the range of 95° F to 180° F, and it also works as a diagnostic tool that will give a concise error code whenever there is a problem with the unit. The temperature options are 95°, 100°, 102°, 104°, 106°, 108°, 109°, 111°, 113°, 115°, 117°, 122°, 131°, 140°, 158°, 167° and 180° F. See the troubleshooting section for information on possible error codes.

TK-TV01 Vent Terminator



This terminator can be used where a T-K2 is going to be vented out through a wall. This is an AGA approved part of the unit. Connect a Category III Special Gas Vent from the top of the unit to the

backside of this terminator to exhaust flue gases through the wall without a large thimble. Install vent terminator in accordance with manufacturer's installation instructions and any applicable codes.

TK-TV03 Vent Damper

The TK-TV03 Vent Damper prevents the backflow of air through the exhaust vent. This is also an AGA approved part of the unit. This helps prevent harmful exhaust gases from entering the home, as well as helping to prevent the units from freezing in areas where cold air can be blown into the exhaust system. Install vent damper according to manufacturer's installation instructions, and any applicable codes.

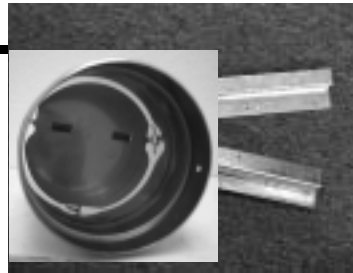

Wall Mounting Brackets

The TK-BK01 Wall Mounting Brackets allow the T-K2 to be installed hanging from a wall. It is not necessary to use an earthquake strap

on these heaters if these brackets are used. If the unit is not going to be mounted on a wall, the "L" brackets that are included with every unit will be sufficient as earthquake protection. Install unit and brackets according to manufacturer's installation instructions and any applicable codes.

FLASH WATER HEATER
 T-K1
 PARTS LIST
 HOUSING COMPONENTS DIAGRAM

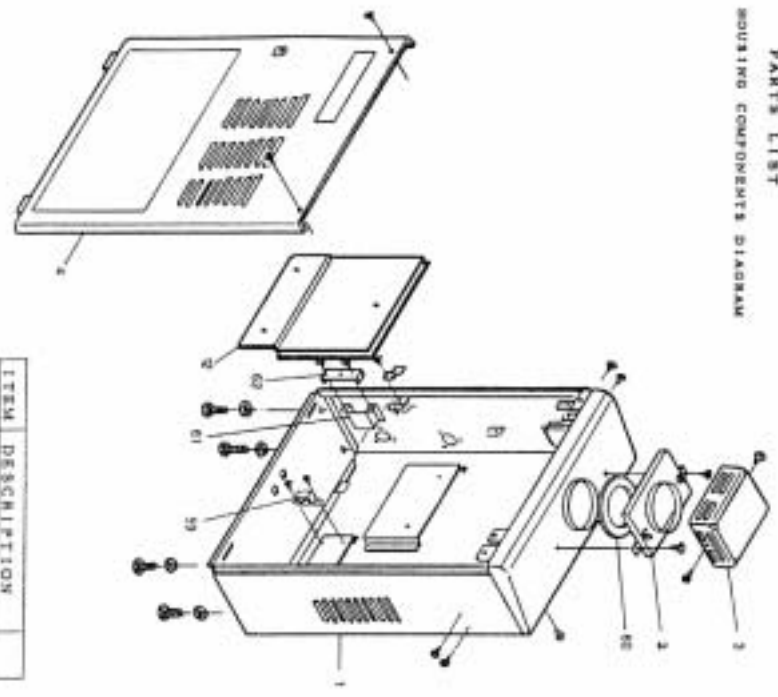

ITEM	DESCRIPTION
1	FRONT PANEL
2	TOP COVER
3	TOP SCREW
4	FRONT SCREW
5	BACK SCREW
6	FRONT NUT
7	FRONT WASHER
8	FRONT WASHER
9	FRONT WASHER
10	FRONT WASHER
11	FRONT NUT
12	FRONT NUT

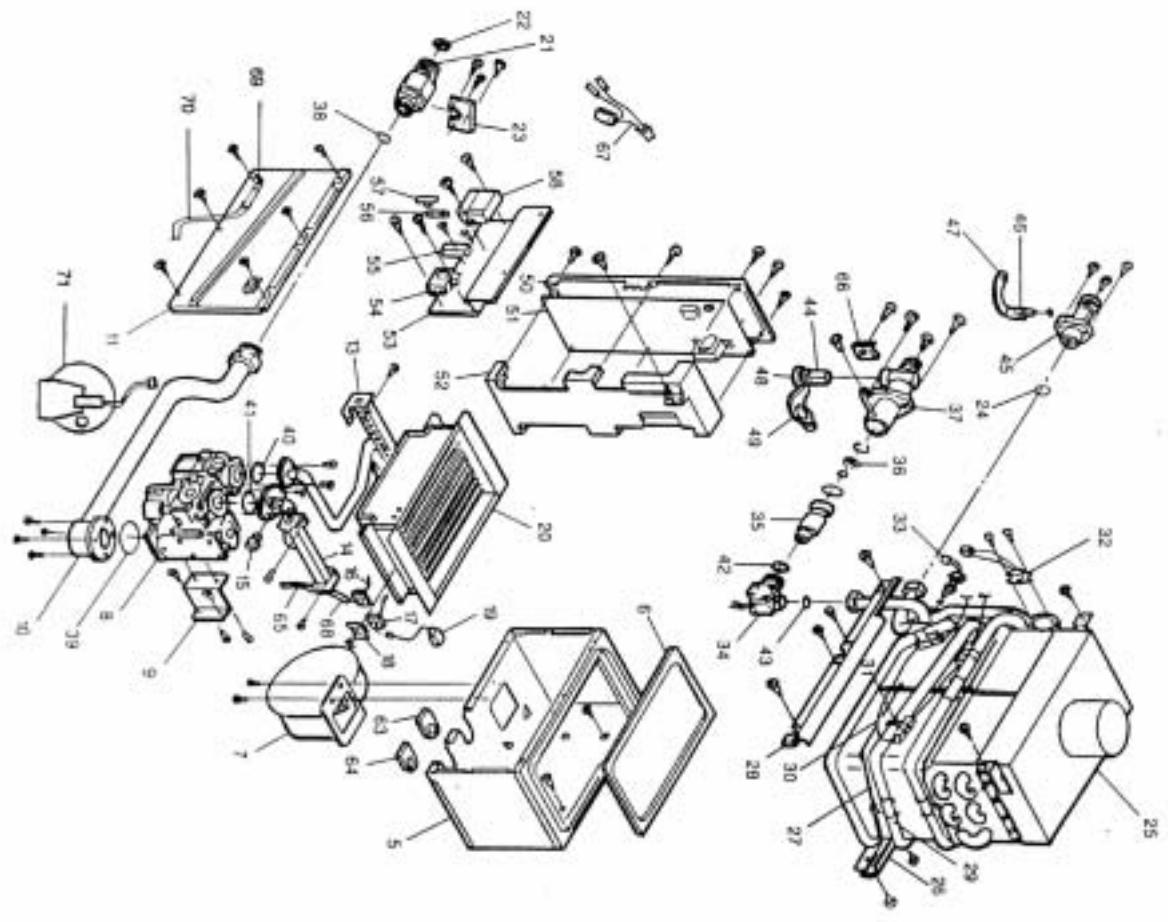

PARTS LIST

ITEM	DESCRIPTION	ITEM	DESCRIPTION
1	CASE ASSEMBLY	2	TOP ASSEMBLY
3	OUT DOOR VENT CAP	4	FRONT COVER
5	COMBUSTION CHAMBER	6	PACKING
7	FAN MOTOR	8	GAS VALVE UNIT
9	VALVE FIXING PLATE	10	GAS IN PIPE
11	COMBUSTION CHAMBER FRONT	12	BACK GUARD PANEL
13	LEFT MANIFOLD	14	RIGHT MANIFOLD
16	SPARK ELECTRODE	17	FLAME DETECTOR
18	FIXING PLATE	19	FLAME DETECTOR WIRE
20	BURNER ASSEMBLY	21	GAS INLET
22	GAS FILTER	23	FIXING PLATE
24	SEAL PACKING	25	HEAT EXCHANGER ASSEMBLY
26	HEAT EXCHANGER FIXING PLATE	27	OVER HEAT CUT OFF FUSE
28	HEAT EXCHANGER FIXING PLATE	29	FUSE FIXING PLATE
30	HEATER BLOCK ASSEMBLY	31	HEATER FIXING PLATE
32	HI - LIMIT SWITCH	33	THERMISTOR ASSEMBLY
34	FLOW SENSOR	35	WATER GOVERNOR CASE
36	WATER GOVERNOR	37	WATER INLET
38	O-RING	39	O-RING
40	O-RING	41	O-RING
42	O-RING	43	JOINT PACKING
44	FILTER	45	WATER OUTLET
46	DRAIN PLUG	47	DRAIN BAND
48	DRAIN PLUG	49	DRAIN BAND
50	CONTROL BOX "A"	51	CIRCUIT PLATE
52	CONTROL BOX "B"	53	PLATE
54	IGNITER	55	FUSE BOX
56	FUSE	57	FUSE COVER
58	GROUND FAULT INTERRUPTER	59	TRANSFORMER
60	SILICON RING	63	RUBBER BUSHING "A"
64	RUBBER BUSHING "B"	65	IGNITION WIRE
66	SEAL PLATE	67	THERMOSTAT
68	SILICON CAP	69	PRESSURE SWITCH PORT
70	SILICON TUBE	71	PRESSURE SWITCH

Flow Rate vs. Temperature

Hot Water Out Rate and Temperature with Various Ground Temperature

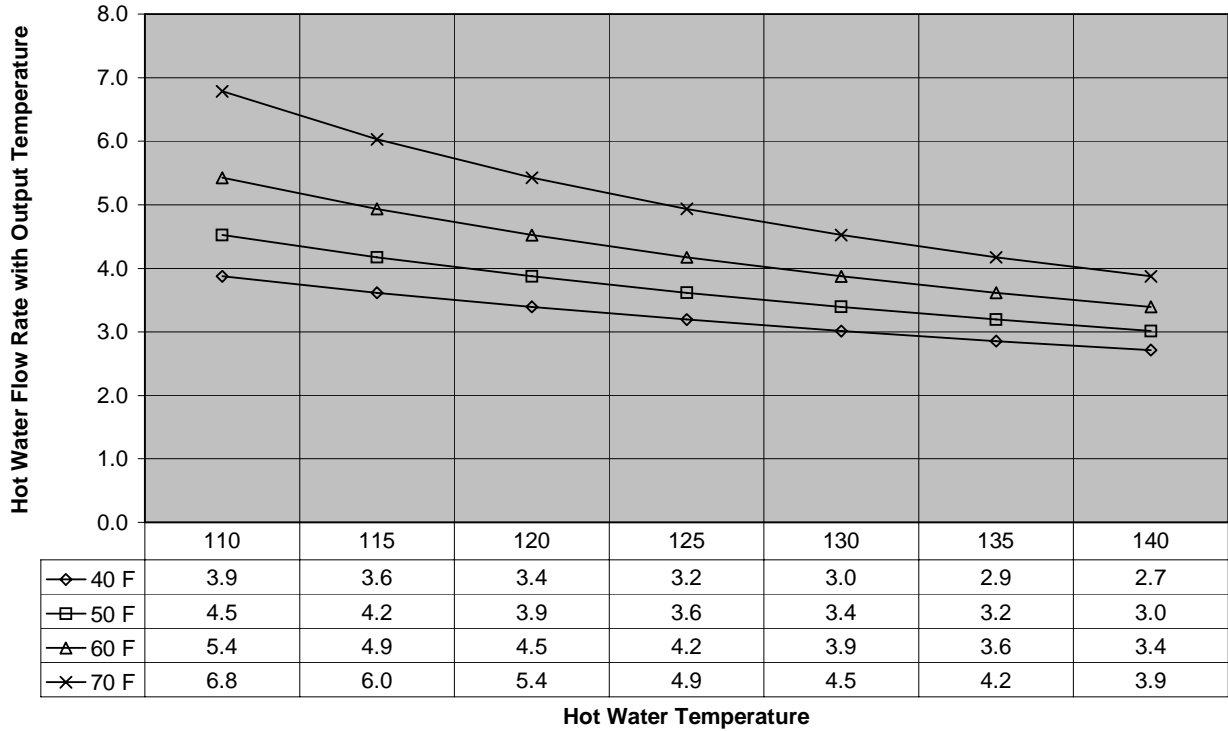

Ground Water Temperature vs. Hot Water Flow Rate

